

BLADE OS™

BBI Quick Guide

BNT Layer 2-7 GbE Switch Module for IBM BladeCenter®
Version 21.0

Part Number: 24R9744, March 2006

BLADE
NETWORK TECHNOLOGIES

2350 Mission College Blvd.
Suite 600
Santa Clara, CA 95054
www.bladenetwork.net

Copyright 2009 Blade Network Technologies, Inc., 4655 Great America Parkway, Santa Clara, California 95054, USA. All rights reserved. Part Number: 24R9744

This document is protected by copyright and distributed under licenses restricting its use, copying, distribution, and decompilation. No part of this document may be reproduced in any form by any means without prior written authorization of Blade Network Technologies, Inc. Documentation is provided “as is” without warranty of any kind, either express or implied, including any kind of implied or express warranty of non-infringement or the implied warranties of merchantability or fitness for a particular purpose.

U.S. Government End Users: This document is provided with a “commercial item” as defined by FAR 2.101 (Oct. 1995) and contains “commercial technical data” and “commercial software documentation” as those terms are used in FAR 12.211-12.212 (Oct. 1995). Government End Users are authorized to use this documentation only in accordance with those rights and restrictions set forth herein, consistent with FAR 12.211- 12.212 (Oct. 1995), DFARS 227.7202 (JUN 1995) and DFARS 252.227-7015 (Nov. 1995).

Blade Network Technologies, Inc. reserves the right to change any products described herein at any time, and without notice. Blade Network Technologies, Inc. assumes no responsibility or liability arising from the use of products described herein, except as expressly agreed to in writing by Blade Network Technologies, Inc. The use and purchase of this product does not convey a license under any patent rights, trademark rights, or any other intellectual property rights of Blade Network Technologies, Inc.

BLADE OS is a trademark of Blade Network Technologies, Inc. in the United States and certain other countries. Any other trademarks appearing in this manual are owned by their respective companies.

Originated in the U.S.A.

Contents

Preface 5

- Who Should Use This Book 5
- Related Documentation 5
- Typographic Conventions 6
- How to Get Help 7

Chapter 1: Getting Started 9

- Features 9
- Requirements 10
- Switch Set Up 10
 - IP Interfaces 10
 - Enabling/Disabling BBI Access 10
- Web Browser Set Up 11
- Starting the BBI 11

Chapter 2: Browser-Based Interface Basics 15

- Toolbar 16
 - Context Buttons 16
 - Commands 17
- Navigation Window 18
- Forms Window 19
- Message Window 19

Chapter 3: Configuring the Switch 21

- Configuration Steps 21
 - Using the BBI to Load Switch Software 23

Chapter 4: Viewing Statistics 27

- Steps for Displaying Statistics 27

Chapter 5: The Dashboard 29
Steps for Displaying Dashboards 29

Preface

BLADE OS Browser-Based Interface (BBI) software is included in the GbE Switch Module. The BBI software lets you use your Web browser to access switch information and statistics, and to perform switch configuration via the Internet.

This *BBI Quick Guide* provides an overview of how to access and use the Browser-Based Interface.

Who Should Use This Book

This *BBI Quick Guide* is intended for network installers and system administrators engaged in configuring and maintaining a network. It assumes that you are familiar with your GbE Switch Module, your Web browser, Ethernet concepts, IP addressing, the IEEE 802.1d Spanning Tree Protocol, and SNMP configuration parameters.

Related Documentation

For documentation on installing the switch physically, see the *Installation Guide* for your GbE Switch Module.

For details about the switch information, statistics, and configuration parameters available using the BLADE OS BBI, see the Layer 2-7 GbE Switch Module *Command Reference* and *Application Guide*.

Typographic Conventions

The following table describes the typographic styles used in this book.

Table 1 Typographic Conventions

Typeface or Symbol	Meaning	Example
AaBbCc123	This type is used for names of commands, files, and directories used within the text. It also depicts on-screen computer output and prompts.	View the <code>readme.txt</code> file. Main#
AaBbCc123	This bold type appears in command examples. It shows text that must be typed in exactly as shown.	Main# sys
<AaBbCc123>	This italicized type appears in command examples as a parameter placeholder. Replace the indicated text with the appropriate real name or value when using the command. Do not type the brackets. This also shows book titles, special terms, or words to be emphasized.	To establish a Telnet session, enter: host# telnet <IP address> Read your <i>User's Guide</i> thoroughly.
[]	Command items shown inside brackets are optional and can be used or excluded as the situation demands. Do not type the brackets.	host# ls [-a]

How to Get Help

If you need help, service, or technical assistance, see the "Getting help and technical assistance" appendix in the BNT Layer 2-7 GbE Switch Module for IBM BladeCenter *Installation Guide*.

CHAPTER 1

Getting Started

This chapter briefly describes the software features and requirements for the BLADE OS Browser-Based Interface (BBI), and explains how to access the BBI start page.

Features

The network administrator can access all switch configuration and monitoring functions through the BBI, a Web-based switch management interface. The BBI has the following features:

- Many of the same configuration and monitoring functions as the command-line interface
- Intuitive and easy-to-use interface structure
- Password protection
- Nothing to install; the BBI is part of the BLADE OS switch software
- Automatically upgraded with each new software release

NOTE – You can perform most configuration and monitoring tasks through the BBI. For a comprehensive set of commands, use the command-line interface. Refer to the Layer 2-7 GbE Switch Module *Command Reference*.

Requirements

- GbE Switch Module
- Installed BLADE OS switch software
- PC or workstation with network access to the switch
- Frame-capable Web-browser software, such as the following:
 - Netscape Navigator 4.7x or higher
 - Internet Explorer 6.0x or higher
- JavaScript enabled in your Web browser

Switch Set Up

Before you can access the BBI, minimal configuration is required on the GbE Switch Module.

IP Interfaces

At least one IP interface must be configured on the switch. This is usually done from the command-line interface during first-time switch set up. Each IP interface address provides a point of access for BLADE OS switch management. The default management interface is 128, which allows access to BLADE OS switch management via the management module network only.

For complete information about configuring IP interfaces, see your GbE Switch Module *Installation Guide*.

Enabling/Disabling BBI Access

By default, BBI access is enabled. If you need to disable or re-enable access, use the following command from the GbE Switch Module command-line interface:

```
>> Main# /cfg/sys/access/http <disable|enable (or just d|e)>
```

For more information on the accessing and configuring the switch through the command-line interface, see your GbE Switch Module *Installation Guide*.

Web Browser Set Up

Most modern Web browsers work with frames and JavaScript by default, and require no additional set up. However, you should check your Web browser's features and configuration to make sure frames and JavaScript are enabled.

NOTE – JavaScript is not the same as Java. Please make sure that JavaScript is enabled in your Web browser.

Starting the BBI

When the switch and browser set up is done, follow these steps to launch the BBI:

1. **Start your Web browser.**
2. **Enter the switch IP interface address in the Web browser's URL field.**

For example, consider an IP interface with a network IP address of 1.90.90.96. Using a Web browser, you could enter the following:

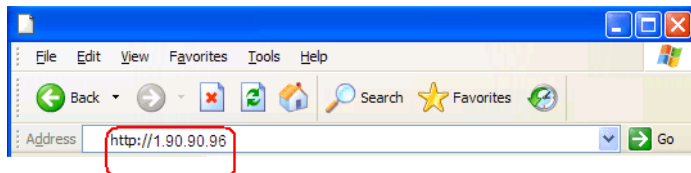

If the IP interface's address has a name on your local domain name server, you could enter the name instead. For example, with Internet Explorer, you could enter the following:

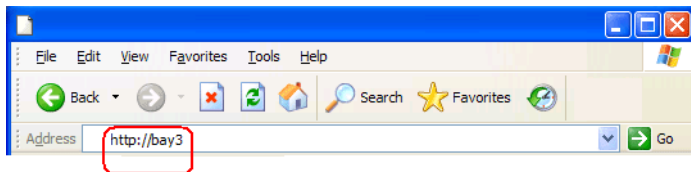

3. Log in to the switch.

If your switch and browser are properly configured, you will be asked to enter a password:

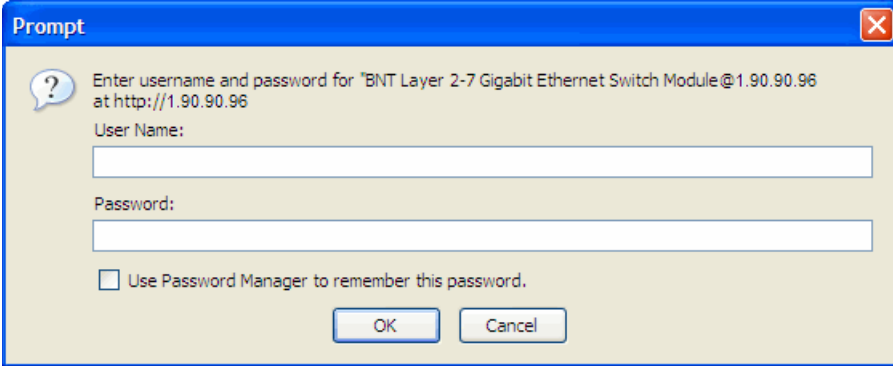

The image shows a dialog box titled "Prompt" with a blue header and a red close button in the top right corner. The dialog box has a light beige background. On the left side, there is a question mark icon inside a speech bubble. To the right of the icon, the text reads: "Enter username and password for 'BNT Layer 2-7 Gigabit Ethernet Switch Module@1.90.90.96' at http://1.90.90.96". Below this text, there are two input fields: "User Name:" followed by a white text box, and "Password:" followed by a white text box. At the bottom left of the dialog, there is a checkbox with the label "Use Password Manager to remember this password." At the bottom center, there are two buttons: "OK" and "Cancel".

Enter the account name and password for the switch's administrator or user account. The default account name is *admin*, and the default password is *admin*. For more password information, see your *Command Reference* manual.

4. Allow the BBI Dashboard page to load.

When the proper account name and password combination is entered, the BBI Dashboard page is displayed in your browser's viewing area:

The screenshot shows a web browser window displaying the BLADE OS BBI Dashboard. The browser's address bar contains the URL `http://1.90.90.96`. The page header includes the BLADE OS logo and navigation tabs for CONFIGURE, STATISTICS, and DASHBOARD. Below the header, there is a navigation pane on the left with a folder icon and the text "BNT Layer 2-7 Gigabit Ethernet S". The main content area displays the "Switch Dashboard" with a table of switch information.

Switch Name	
Switch Location	
Switch Type	BNT Layer 2-7 Gigabit Ethernet Switch Module
Last Boot Time	0:01:00 Thu Jan 1, 2008 (power cycle)
MAC Address	00:0c:f8:2b:14:00
Switch Software Version	21.0.1
Flash Configuration	FLASH image1, factory default configuration.
PCBA Part Number	316210-A
FAB Number	EL4512001
Serial Number	VJ1RTK37Z428
Manufacturing Date	0332
Hardware Revision	0
PLD Firmware Version	3.6
Temperature Sensor 1	50.5 C (Warn at 75.0 C/Recover at 70.0 C)

NOTE – There may be a slight delay while the Dashboard page is being initialized. You should not stop the browser while loading is in progress. When loading is complete, a folder icon will appear in the left-hand navigation window.

CHAPTER 2

Browser-Based Interface Basics

Once you are properly logged in, the Browser-Based Interface (BBI) appears in your Web browser's viewing window:

The screenshot displays the BLADE OS interface. At the top, the 'BLADE NETWORK TECHNOLOGIES' logo is on the left, and 'BLADE OS' is on the right. Below the logo is a navigation bar with tabs for 'CONFIGURE', 'STATISTICS', and 'DASHBOARD'. A toolbar below the tabs contains buttons for 'Apply', 'Save', 'Revert', 'Diff', 'Dump', 'DumpBk', and 'DumpAc'. A 'Message window' is located on the right side of the top bar, containing 'Show Log', 'Help', and 'Logout' buttons. The main content area is titled 'Switch Dashboard' and contains a table with the following information:

Switch Name	
Switch Location	
Switch Type	BNT Layer 2-7 Gigabit Ethernet Switch Module
Last Boot Time	0:01:00 Thu Jan 1, 2008 (power cycle)
MAC Address	00:0c:f8:2b:14:00
Switch Software Version	21.0.1
Flash Configuration	FLASH image1, factory default configuration.
PCBA Part Number	316210-A
FAB Number	EL4512001
Serial Number	YJ1RTK37Z428
Manufacturing Date	0332
Hardware Revision	0
PLD Firmware Version	3.6
Temperature Sensor 1	50.5 C (Warn at 75.0 C Recover at 70.0 C)

Labels with arrows point to the 'Toolbar', 'Message window', 'Navigation window', and 'Forms window'.

There are four main regions on the BBI screen:

- The Toolbar is used for selecting the context for your actions in the other windows.
- The Message window is used for displaying the latest `syslog` messages and events.
- The Navigation window is used for selecting particular items or features to act upon.
- The Forms window is used for viewing or altering switch information.

Toolbar

Context Buttons

The toolbar is used for setting the context for your actions in the application. There are three context buttons:

Configure	When selected, you can access the switch configuration forms. Configuration forms can be altered only if you are logged in using the administrator account. Select an item in the navigation window to display the desired configuration form in the forms window.
Statistics	When selected, you can view information about switch performance. Select an item in the navigation window to display the desired statistics in the forms window.
Dashboard	This context button is selected by default when the BBI is first activated. When selected, basic switch information and status can be viewed in the forms window. Select an item in the navigation window to display the desired dashboard information in the forms window.

When a context icon is selected, the button will be highlighted as a reminder of the current context mode.

Commands

The following general commands are available on the toolbar:

Apply	Pending configuration changes do not take effect until the Apply command is selected. Once applied, all changes take effect on the switch immediately. If you do not save the changes, however, they will be lost the next time the switch is rebooted.
Save	Writes applied configuration changes to non-volatile flash memory on the switch.
Revert	Remove pending configuration changes between “apply” commands. Use this command to restore configuration parameters set since last “apply” command.
Diff	Show any pending configuration changes.
Dump	Dump the current switch configuration to a script file.
DumpBk	Dump the backup configuration to a script file.
DumpAc	Dump the active configuration to a script file.
Show Log	Opens a new Web-browser window for displaying the 64 most recent switch log messages. Close the log browser when finished.
Help	Opens a new Web-browser window for displaying the basic online help information. Close the help browser when finished.
Logout	Log off the switch and exit the BBI.

Navigation Window

The navigation window is used for selecting a particular switch feature to act upon. Status, statistics, or configuration forms for the selected item will appear in the forms window, depending on the context chosen on the toolbar.

The navigation window contains a tree of folders, sub-folders, and feature icons:

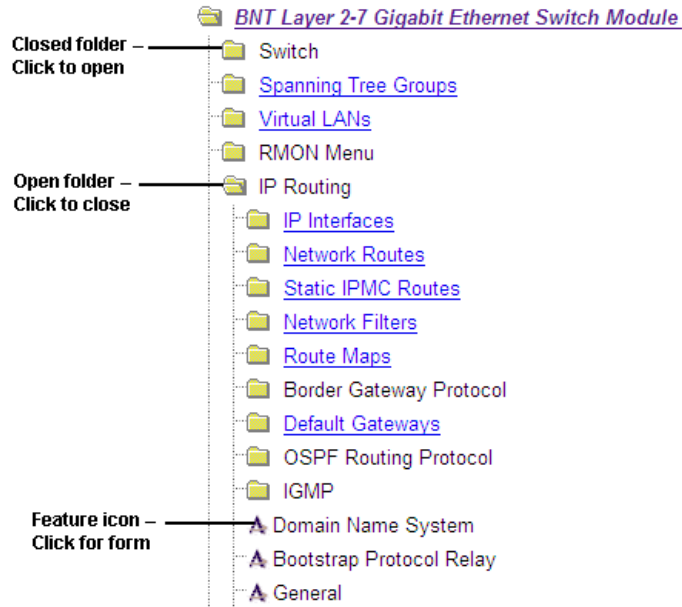

You can click on any closed folder to open it and reveal its contents. Click on any open folder to close it. Click on any feature icon to load the appropriate status, statistics, or configuration form in the forms window.

Some folders also have forms. If the name of the folders is underlined, click on the name to display the appropriate form.

Forms Window

When a feature icon is selected on the navigation window, a status, statistics, or configuration form is displayed in the forms window. The exact nature of the form depends on the current context selected on the toolbar, as well as the type of information available. Not all feature icons have forms for all contexts.

Some forms display switch information such as settings, status, or statistics. Others allow you to make configuration changes to switch parameters.

Message Window

Switch log messages are generated by events such as login/logout activity, password changes, configuration changes, and switch reboot. The BBI records the most recent messages and displays each one briefly in the message window. When the last message has been displayed, the cycle repeats.

To view all available messages at the same time, select the Show Log command on the toolbar. A new Web-browser window will be opened to display the log information. Close the window when finished.

For a list of `syslog` messages, see your *Command Reference* manual.

CHAPTER 3

Configuring the Switch

The Browser-Based Interface (BBI) can be used to view and change switch configuration parameters. The same configuration parameters that are available through the switch's command-line interface are present on the BBI configuration forms.

The following provides a basic outline for switch configuration. You should first be familiar with configuration as covered in the Layer 2-7 GbE Switch Module *Command Reference*.

NOTE – You must be logged in using the administrator account in order to change switch configuration settings.

Configuration Steps

Follow these basic steps for viewing or configuring switch parameters:

1. **Select the Configure context button in the toolbar:**



2. Select a feature icon in the navigation window. For example:

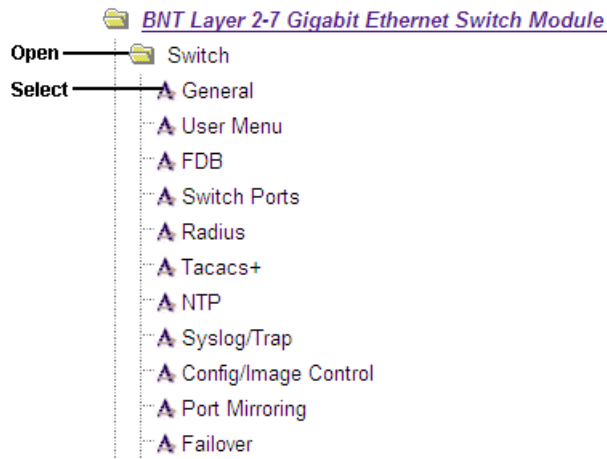

3. View or make changes to the settings shown in the forms window. For example:

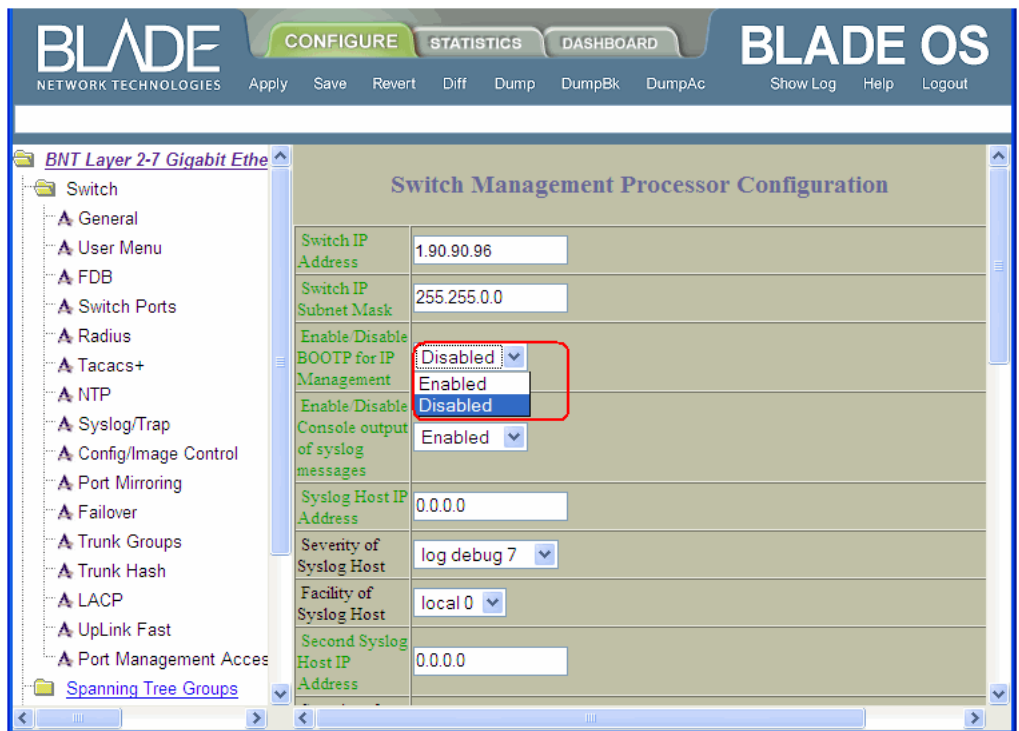

NOTE – Fields which must be configured for proper switch operations are highlighted on the forms in **GREEN** type. Items which load other forms when selected are underlined.

4. **Submit, reset, or delete the form contents using buttons on the bottom of the form.**

Submit	When selected, the form is sent to the switch. Any configuration changes are placed in the “pending” state and do not take effect until the toolbar Apply command is given.
Reset	When selected, the form fields are reset to their last submitted values.
Delete	This button is available for configuration items that can be deleted. When selected, the featured item is slated to be removed from the switch configuration database. The item is not actually deleted, however, until the toolbar Apply command is given.

5. **Apply and save your changes using the toolbar commands.**

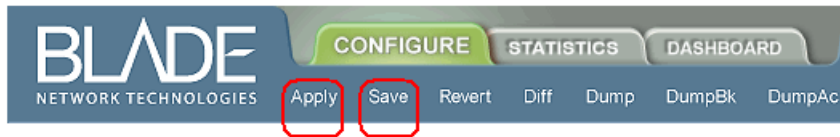

Pending configuration changes (including deletions) do not take effect until the Apply command is selected.

Applied changes take effect on the switch immediately, but will be lost the next time the switch is rebooted unless the Save command is selected.

Using the BBI to Load Switch Software

You can use the Browser-Based Interface to load software onto the GbE Switch Module (GbESM). The software image to load can reside in one of the following locations:

- FTP server
- TFTP server
- Local computer

After you log onto the BBI, perform the following steps to load a software image:

1. **Click the Configure context button in the toolbar:**

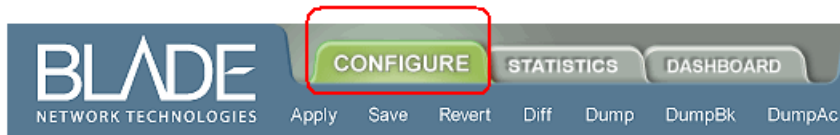

- In the Navigation Window, select System > Config/Image Control.

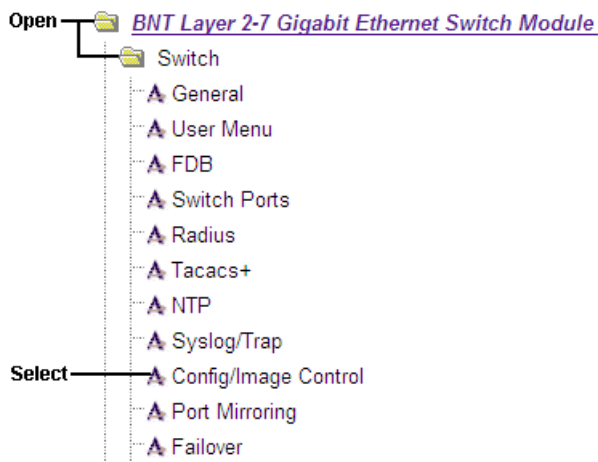

The Switch Image and Configuration Management form appears.

Switch Image and Configuration Management

Image 1 Version	version 21.0.0, downloaded 0:07:04 Thu Jan 1, 2005	
Image 2 Version	version 21.0.1, downloaded 0:07:45 Thu Jan 1, 2005	
Boot Version	version 21.0.0	
Active Image Version	21.0.0	
Next Boot Image Selection	image 2 ▼	

Active Configuration Block	active config
Next Boot Configuration Block Selection	active config ▼

<u>FTP/TFTP Settings</u>	
Hostname or IP Address of FTP/TFTP server	100.10.20.1
Username for FTP Server or Blank for TFTP Server	
Password for FTP Server	

<u>Image Settings</u>	
Image for Transfer	image 2 ▼
Image Filename (on server)	21.0.1_O5.img Get Image Put Image
Image Filename (on HTTP Client)	<input type="text"/> Browse... Download via Browser

3. If you are loading software from your computer (HTTP client), go to Step 4. If you are loading software from a FTP/TFTP server, enter the server's information in the FTP/TFTP Settings section.

FTP/TFTP Settings	
Hostname or IP Address of FTP/TFTP server	100.10.20.1
Username for FTP Server or Blank for TFTP Server	
Password for FTP Server	

4. In the Image Settings section, select the image version you want to replace (Image for Transfer).

Image Settings	
Image for Transfer	image 2 ▾
Image Filename (on server)	21.0.2_05.img <input type="button" value="Get Image"/> <input type="button" value="Put Image"/>
Image Filename (on HTTP Client)	<input type="text"/> <input type="button" value="Browse..."/> <input type="button" value="Download via Browser"/>

- If you are loading software from a FTP/TFTP server, enter the file name and click Get Image.
- If you are loading software from your computer, click Browse. In the File Download Dialog, select the file and click OK. Click Download via Browser.

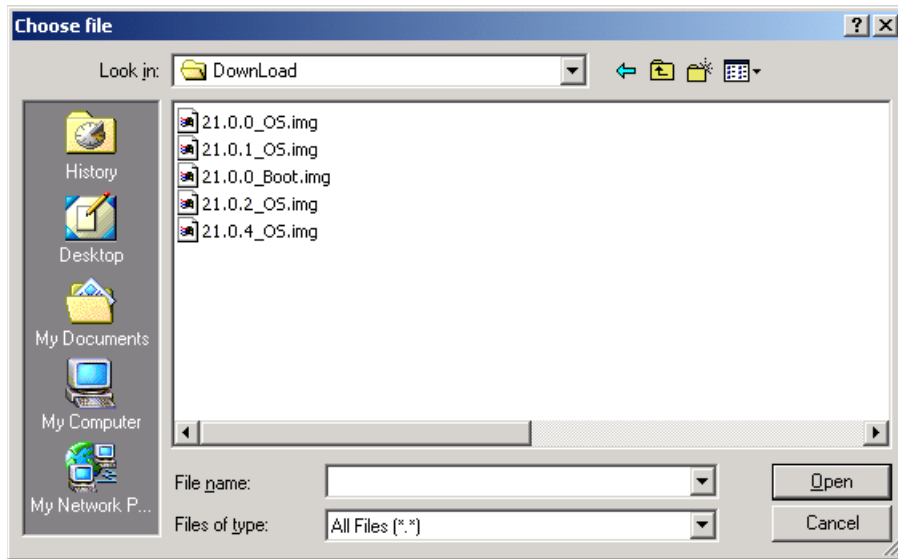

Once the image has loaded, the page refreshes to show the new software.

CHAPTER 4

Viewing Statistics

The BLADE OS Browser-Based Interface (BBI) can be used to view a variety of switch performance statistics. The same statistics that are available through the switch's command-line interface are present on the BBI statistics forms.

The following provides a basic outline for viewing statistics. You should first be familiar with available statistics as covered in the *Command Reference* manual.

Steps for Displaying Statistics

Follow these basic steps for viewing switch statistics:

1. **Select the Statistics context button in the toolbar:**

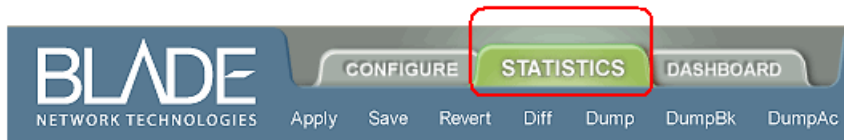

2. **Select a feature icon in the navigation window. For example:**

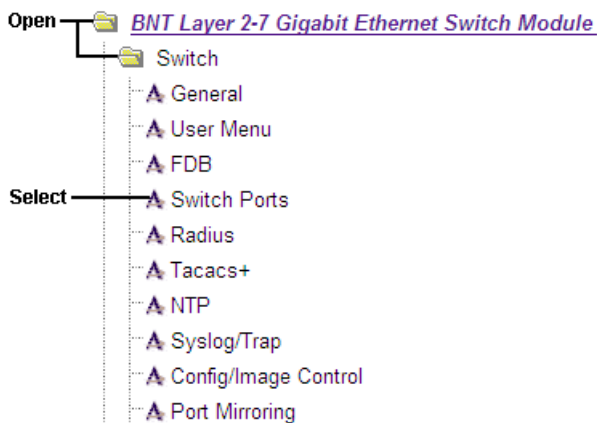

3. View the statistics in the forms window. For example:

The screenshot shows the BLADE OS web interface. The top navigation bar includes 'CONFIGURE', 'STATISTICS', and 'DASHBOARD' tabs. Below the tabs are buttons for 'Apply', 'Save', 'Revert', 'Diff', 'Dump', 'DumpBk', 'DumpAc', 'Show Log', 'Help', and 'Logout'. The main content area is titled 'Switch Ports Statistics Summary' and contains a table with the following data:

Switch Port	InOctets	OutOctets	Total Errors
INT1	0	0	0
INT2	0	0	0
INT3	0	0	0
INT4	0	0	0
INT5	0	0	0
INT6	0	0	0
INT7	0	0	0
INT8	0	0	0
INT9	0	0	0
INT10	0	0	0
INT11	0	0	0
INT12	0	0	0
INT13	0	0	0
INT14	0	0	0
MGT1	297190	340486	0
MGT2	0	0	0
EXT1	0	0	0
EXT2	0	0	0

NOTE – The sample screens that appear in this document might differ slightly from the screens displayed by your system. Screen content varies based on the type of BladeCenter unit that you are using and the firmware versions and options that are installed.

NOTE – Items which load other forms when selected are [underlined](#).

CHAPTER 5

The Dashboard

The BLADE OS Browser-Based Interface (BBI) can be used to view the present settings and operating status of a variety of switch features. The same information available through the switch's command-line interface is present on the dashboard forms.

The following provides a basic outline for viewing the dashboard forms. You should first be familiar with configuration as covered in the *Command Reference* manual.

Steps for Displaying Dashboards

Follow these basic steps for viewing switch dashboard forms:

1. **Select the Dashboard context button in the toolbar:**



2. **Select a feature icon in the navigation window. For example:**

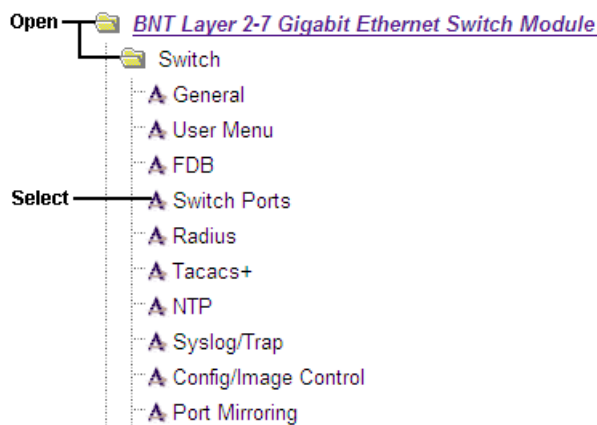

3. View information shown in the forms window. For example:

The screenshot displays the BLADE OS interface with the 'Switch Ports Dashboard' for 'BNT Layer 2-7 Gigabit Ethe'. The dashboard features a table with the following data:

Status	Switch Port Info	Operational Status	Duplex FlowCtl Speed	Input Frames Output Frames	LinkState Changes Total Errors
	INT1 : stp: DISABLED rmon:disabled Port Fast Forward:disabled tagging:enabled PVID:1	operational	Full Both 1000	0 0	0 0
	INT2 : stp: DISABLED rmon:disabled Port Fast Forward:disabled tagging:enabled PVID:1	operational	Full Both 1000	0 0	0 0
	INT3 : stp: DISABLED rmon:disabled Port Fast Forward:disabled tagging:enabled PVID:1	operational	Full Both 1000	0 0	0 0
	INT4 : stp: DISABLED rmon:disabled Port Fast Forward:disabled tagging:enabled PVID:1	operational	Full Both 1000	0 0	0 0
	INT5 : stp: DISABLED rmon:disabled Port Fast Forward:disabled tagging:enabled PVID:1	operational	Full Both 1000	0 0	0 0

NOTE – The sample screens that appear in this document might differ slightly from the screens displayed by your system. Screen content varies based on the type of BladeCenter unit that you are using and the firmware versions and options that are installed.

NOTE – Items which load other forms when selected are underlined.